

# Operation, Care & Maintenance Manual

Kolbe's VistaLuxe® Collection AL LINE of windows and doors is manufactured using Reynaers Aluminium extrusions and system profiles.





DMOA architecten

# OPERATION, CARE & MAINTENANCE MANUAL

**R**  
REYNAERS  
aluminium

# INDEX

|   |           |
|---|-----------|
| <b>1. WARNINGS FOR INCORRECT USE.....</b>       | <b>4</b>  |
| 1.1. Product information.....                   | 5         |
| 1.2. Incorrect use of sashes.....               | 5         |
| 1.3. Incorrect use of handles .....             | 7         |
| 1.4. Incorrect use of locks.....                | 8         |
| <b>2. OPERATION OF WINDOWS.....</b>             | <b>10</b> |
| 2.1. Opening types.....                         | 11        |
| 2.1.1. Turn & tilt window.....                  | 11        |
| 2.1.2. Tilt before turn window .....            | 12        |
| 2.1.3. Side hung window opening inward .....    | 13        |
| 2.1.4. Double casement window .....             | 13        |
| 2.1.5. Hopper window opening inward.....        | 15        |
| 2.1.6. Casement window opening outward .....    | 16        |
| 2.1.7. Awning window opening outward .....      | 16        |
| 2.1.8. Awning window outward projecting .....   | 17        |
| 2.1.9. Vertical pivoting window .....           | 17        |
| 2.1.10. Horizontal pivoting window.....         | 18        |
| 2.1.11. Sliding window .....                    | 19        |
| 2.1.12. Folding window .....                    | 20        |
| 2.1.13. Ventalis.....                           | 20        |
| 2.2. Accessories for windows .....              | 21        |
| 2.2.1. Window Handles .....                     | 21        |
| 2.2.2. Restrictor .....                         | 22        |
| 2.2.3. Ventilation slid.....                    | 23        |
| 2.2.4. Balcony door snapper (roller lock) ..... | 23        |
| <b>3. OPERATION OF DOORS.....</b>               | <b>24</b> |
| 3.1. Opening types .....                        | 25        |
| 3.1.1. Single doors.....                        | 25        |
| 3.1.2. Double doors .....                       | 26        |
| 3.1.3. Pivoting doors.....                      | 27        |
| 3.1.4. Sliding doors .....                      | 27        |
| 3.1.5. Lift sliding doors .....                 | 28        |

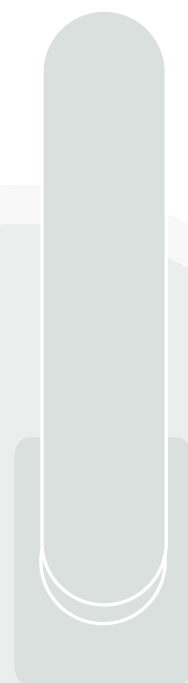

|  |           |
|--|-----------|
| 3.1.6. Folding doors.....  | 29        |
| <b>3.2. Accessories for doors.....</b>                                       | <b>30</b> |
| 3.2.1. Locking and unlocking of single doors.....                            | 30        |
| 3.2.2. Locking and unlocking of double doors.....                            | 31        |
| 3.2.3. Locking and unlocking escape doors / panic doors.....                 | 32        |
| 3.2.4. Door closer .....   | 33        |
| 3.2.5. Restrictor lock .....   | 33        |
| 3.2.6. Door stop .....   | 33        |
| <b>4. CARE AND MAINTENANCE.....</b>  | <b>34</b> |
| <b>4.1. General instructions for cleaning and maintenance.....</b>           | <b>35</b> |
| 4.1.1. Purpose .....   | 35        |
| 4.1.3. Cleaning procedures and care after installation .....                 | 36        |
| 4.1.4. Cleaning precautions .....  | 37        |
| <b>4.2. Maintenance interval.....</b>  | <b>39</b> |
| <b>4.3. Proper procedures for cleaning architectural glass products.....</b> | <b>40</b> |
| <b>4.4. Overall maintenance.....</b>   | <b>43</b> |
| 4.4.1. Maintenance of drainage slots .....                                   | 43        |
| 4.4.2. Maintenance of rails in sliding and lift- and slide elements .....    | 43        |
| 4.4.3. Maintenance of gaskets .....  | 43        |
| 4.4.4. Maintenance of hardware and accessories .....                         | 44        |
| <b>4.5. Cleaning and maintenance of windows.....</b>                         | <b>45</b> |
| 4.5.1. Turn & tilt, turn and tilt & turn .....                               | 45        |
| 4.5.2. Windows with friction stay .....                                      | 46        |
| <b>4.6. Cleaning and maintenance of doors.....</b>                           | <b>47</b> |
| 4.6.1. Single & double doors.....  | 47        |
| 4.6.2. Sliding door.....   | 49        |
| <b>4.7. Cleaning and maintenance of other systems .....</b>                  | <b>50</b> |
| <b>4.8. Care products .....</b>  | <b>51</b> |
| <b>5. IMPORTANCE OF CLIMATE CONTROL AND VENTILATION.....</b>                 | <b>52</b> |
| 5.1. Air tightness combined with good ventilation.....                       | 53        |
| 5.2. Ventilation and climate control .....                                   | 53        |
| <b>6. RECOMMENDATIONS.....</b>   | <b>54</b> |

# 1. WARNINGS FOR INCORRECT USE





## 1.1. PRODUCT INFORMATION

- Windows, doors, sliding systems and folding doors should be installed in a vertical plane. Only dedicated systems with specific hardware can be installed in a slanted position.
- When closing a window, it may be necessary to overcome the resistance of a sealing gasket. Other forms of resistance or obstruction cannot be considered as normal use.
- Special hardware is required for windows with high security against burglary.
- Open windows only have a screening purpose and do not comply with the requirements of wind and water tightness, sound proofing, thermal insulation and high security against burglary.
- In case of wind and draft, windows and doors should be closed to prevent slamming of the vent causing damage or injury.
- A fixed position of the window and door sashes should only be attained with dedicated hardware as described further in this manual.



## 1.2. INCORRECT USE OF SASHES



Risk of injury by getting stuck between window or door sash and frame.



Danger of falling through if sashes are open.



Danger of falling objects and/or related injury, e.g. caused by drafts.

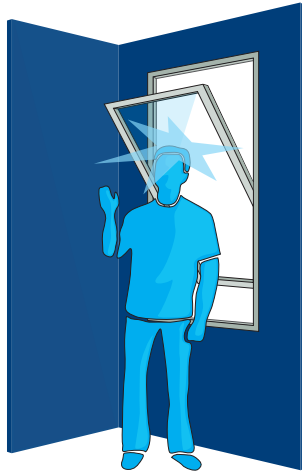

Risk of injury caused by sash impact.

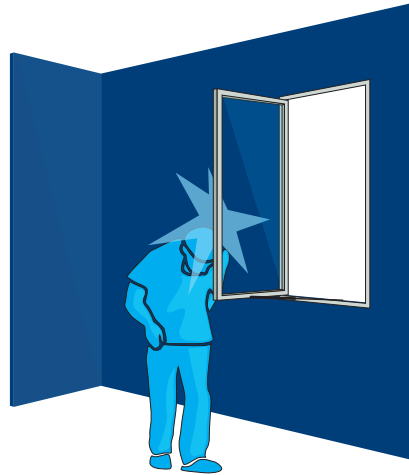

Risk of injury caused by sash impact when sashes are left open.

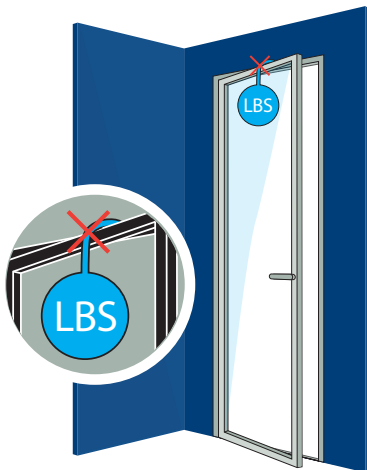

Load on the sashes or leaves can cause damage, deformation or destruction of the individual elements.



In case of double-leaf elements, the active sash must always be opened first (except escape doors) to avoid damage to the lock or frame.

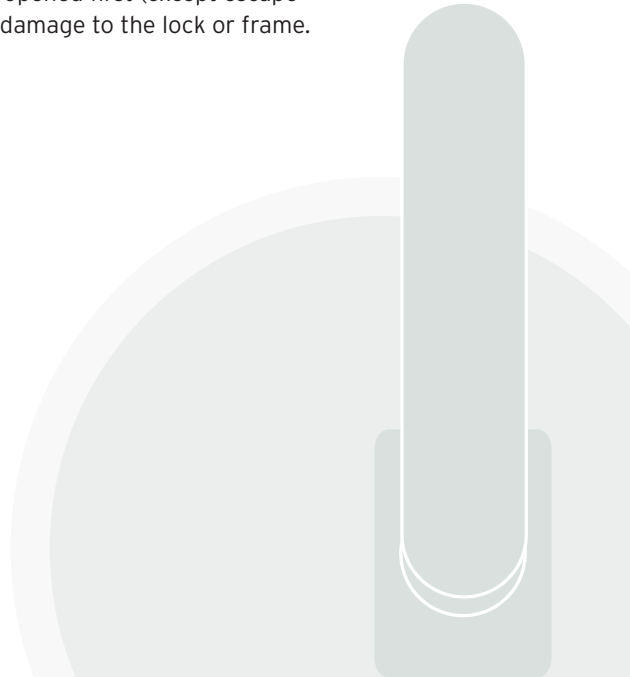

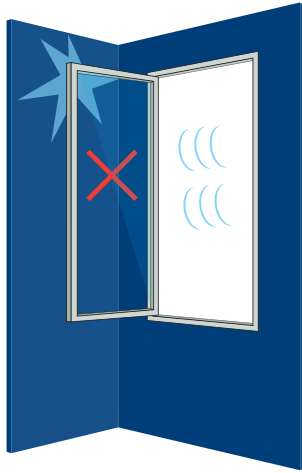

Sashes or leaves banging open in an uncontrolled manner (e.g. caused by wind) against wall recesses can damage the frame, fittings or the recess. Recommendation: use an opening limiter



(regulates the opening distance) or a door stop. Obstacles (e.g. cables, flower pots) in the opening area between sash and frame can cause deformation and damage to frames and fittings.



### 1.3. INCORRECT USE OF HANDLES

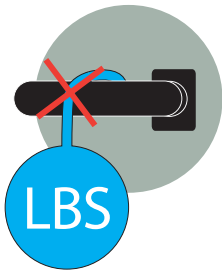

Load on the handle can cause damage to the locking mechanism.

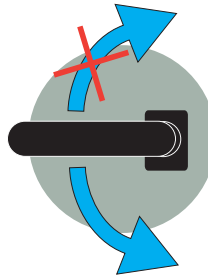

Operate the element handles only in the direction of the arrow as indicated in the manual and only up to the rotation stop. The handle and operating mechanism can be damaged otherwise.

#### OPERATION

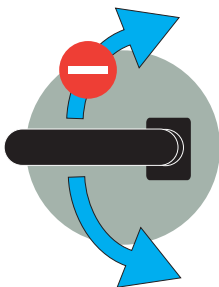

The handle should not be operated while the sash is open. Operating the handle incorrectly may damage the window.

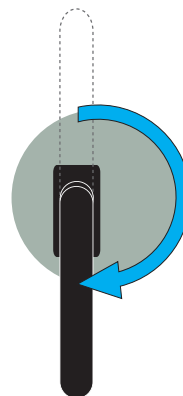

Lift & slide doors should never be operated unless the handle is in the correct, vertical position. If the handle is in the incorrect position during operation, this may damage the door.





## 1.4. INCORRECT USE OF LOCKS

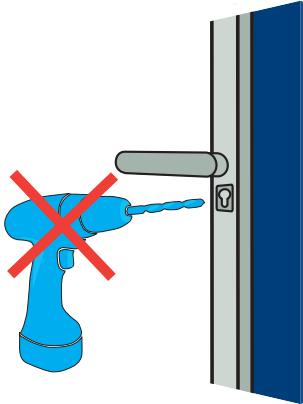

Never drill the fitting when the lock has been installed.



Do not force the lock in case of tightness or sluggish operation. Instead, the cause of the problem should be assessed and fixed by a professional.

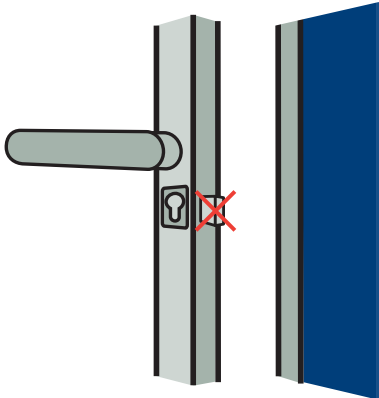

Do not close the door when the bolt is pre-locked: this will damage the lock and the door frame.



In case of a mechanical drive system, please observe the operating and maintenance instructions provided by the drive manufacturers.



## 2. OPERATION OF WINDOWS



Please observe  
the safety remarks  
indicated on p. 5 - 8



## 2.1. OPENING TYPES

### 2.1.1. TURN & TILT WINDOW

By operating the handle of a turn and tilt window, the window can first be opened inwards completely and in second position, the window can be opened in ventilation position.



Please observe  
the safety remarks  
indicated on p. 5 - 8



## 2.1.2. TILT BEFORE TURN WINDOW

Operating the handle of the tilt before turn window will first allow the window to tilt for ventilation purposes. In second position the window can be opened completely inwards.

A specific application of the tilt before turn mechanism is realized in combination with a lockable handle: this handle will always allow the tilt position for ventilation, but will prevent unauthorized persons from opening the window completely.



Please observe the safety remarks indicated on p. 5 - 8



### 2.1.3. SIDE HUNG WINDOW INWARD OPENING

By operating the handle, the window sash can be opened for inward turning.

A handle position with the handle pointing upwards is not possible.



### 2.1.4. DOUBLE CASEMENT WINDOW

A double casement window consists out of 2 sashes with a specific opening sequence. The handle is mounted on the active sash. This active sash can be equipped with a side hung, a turn and tilt or a tilt before turn mechanism. These operating instructions are described in the previous chapters.



\* 1 active sash 2 inactive sash

Please observe  
the safety remarks  
indicated on p. 5 - 8

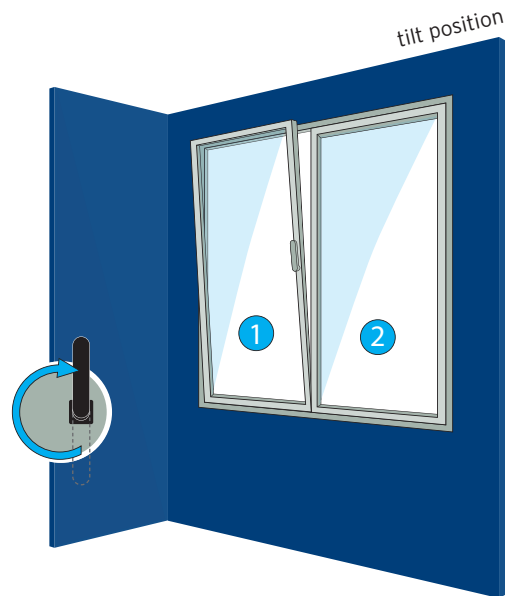

In order to open the inactive (or casement) sash, the active sash needs to be opened inwards completely. The inactive sash is equipped with locking bolts or a central locking mechanism. By unlocking these bolts or central locking mechanism, the inactive sash can be opened in side-hung position. To close the window, simply reverse the order.

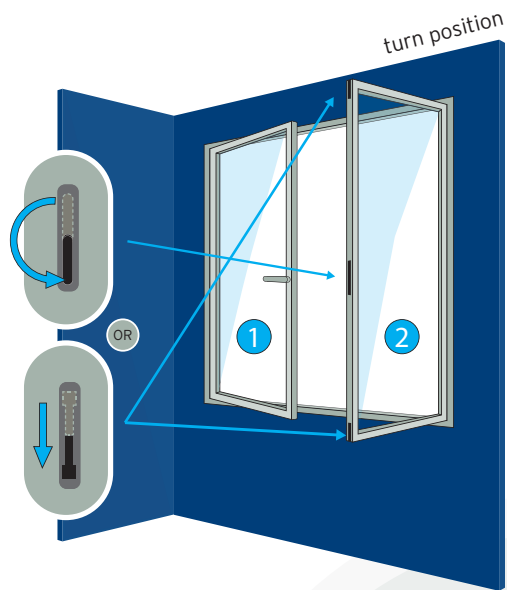

Please observe the safety remarks indicated on p. 5 - 8



## 2.1.5. HOPPER WINDOW INWARD OPENING

This element is equipped with either a handle, lever, spring latch or an automated opening mechanism. By operating the handle or spring latch, the window sash will move to a tilt position.

As a basic principle, bottom hung sashes are secured in the tilt position, to avoid uncontrolled slamming open, by means of stay-arms (tilt safety cleaning stay-arms). These stays can be detached for maintenance of the windows.

### VERTICAL / HORIZONTAL HANDLE

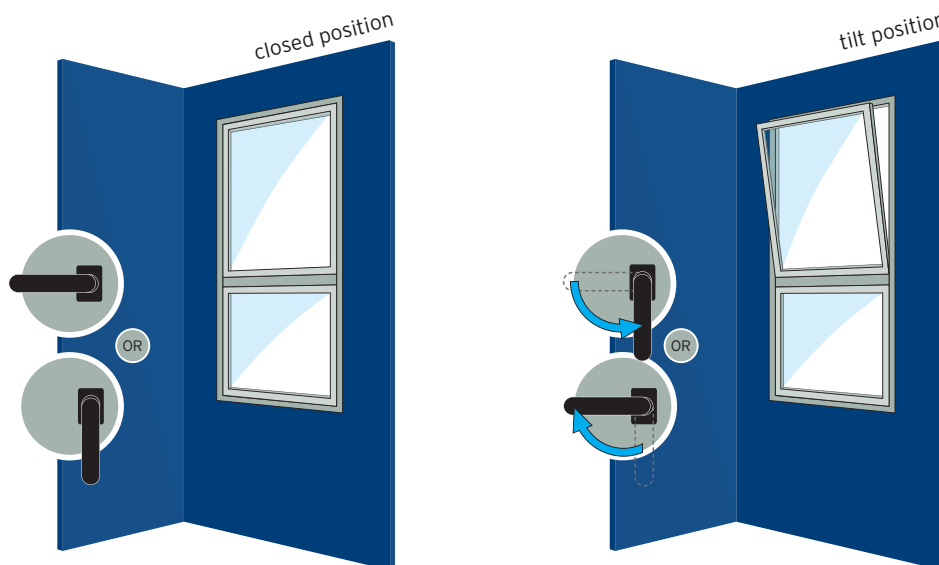

### FANLIGHT ACCESSOIRES

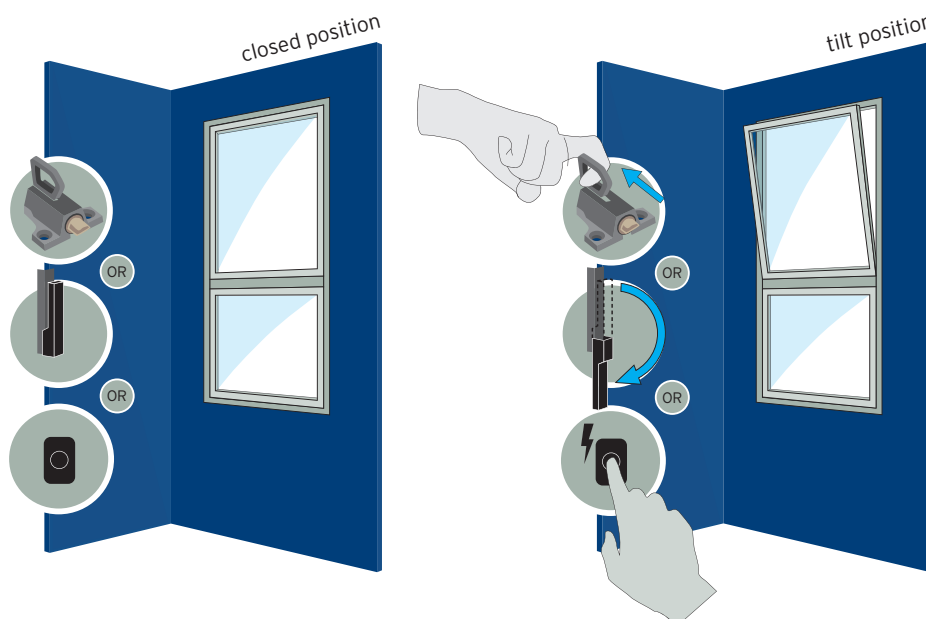



Please observe the safety remarks indicated on p. 5 - 8



## 2.1.6. CASEMENT WINDOW OUTWARD OPENING

By operating the handle, the window sash can be opened towards the outside. An opening limiter is recommended in order to regulate the opening distance. A handle position with the handle pointing upwards is not possible.



## 2.1.7. AWNING WINDOW OUTWARD OPENING

By operating the handle or button, the window sash can be opened towards the outside. The opened sash must be arrested with an opening limiter. A handle position with the handle pointing downwards is not possible.



Please observe  
the safety remarks  
indicated on p. 5 - 8



## 2.1.8. AWNING WINDOW PROJECTING OUTWARD

By operating the handle, the window sash is projected towards the outside, with limited opening angles. A position with the handle pointing downwards is not possible.



## 2.1.9. VERTICAL PIVOTING WINDOW

By operating the handle, the window sash will pivot around the vertical central axis. A position with the handle pointing upwards is not possible.



Please observe  
the safety remarks  
indicated on p. 5 - 8



## 2.1.10. HORIZONTAL PIVOTING WINDOW

By operating the handle, the window sash will pivot around the horizontal central axis. A position with the handle pointing downwards is not possible.

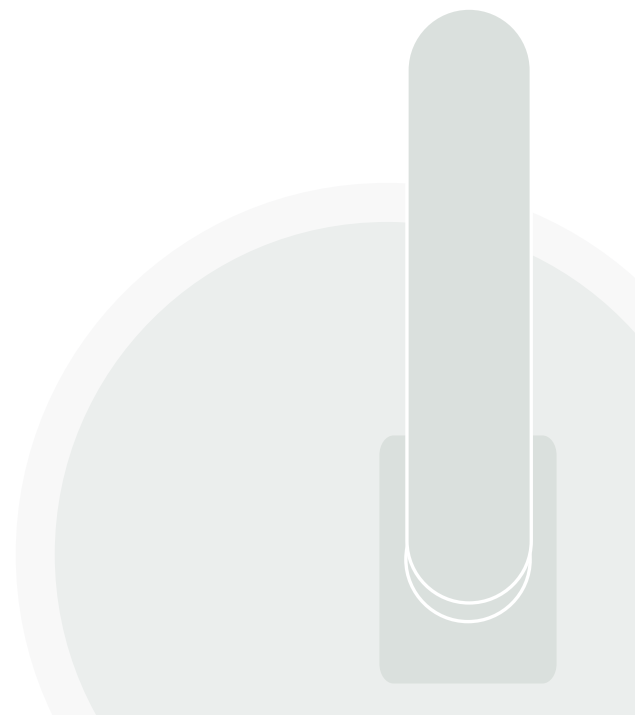
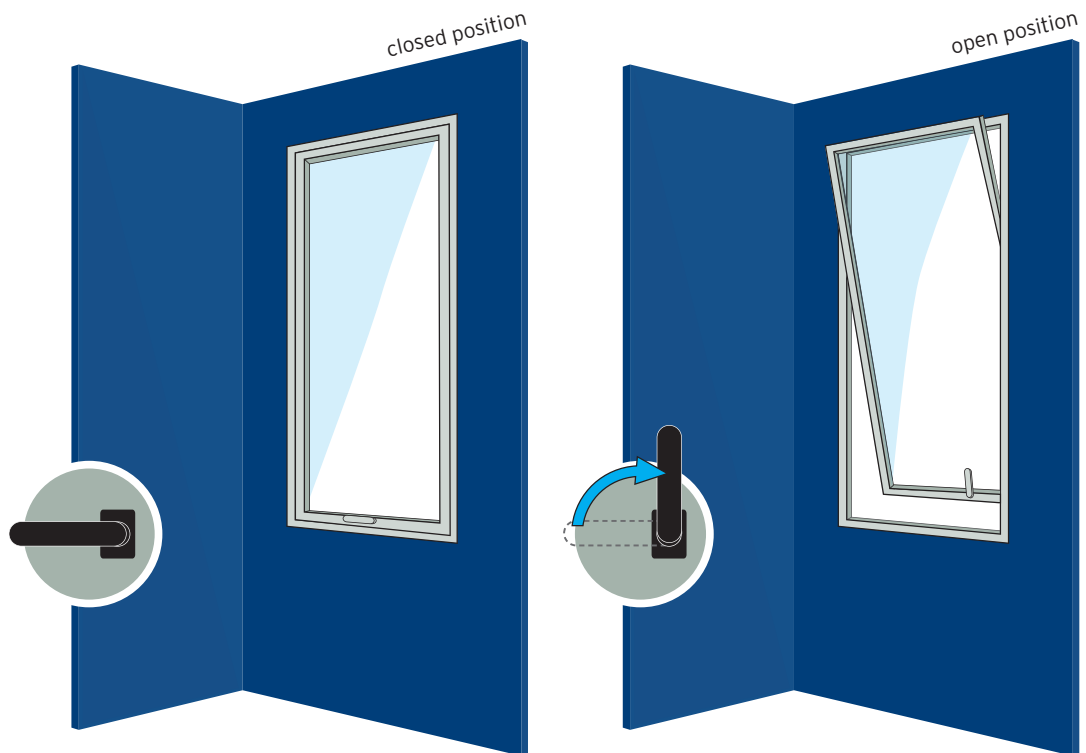

Please observe  
the safety remarks  
indicated on p. 5 - 8



## 2.1.11. SLIDING WINDOW

There are 3 types of opening mechanisms:

- 1. Handle operated:** in order to open the sliding element, turn the handle to a horizontal position (quarter turn) and slide the window open. To close the element, simply reverse the order.
- 2. Sliding elements with a fixed handle** are locked and unlocked by turning the cylinder.
- 3. Integrated handle:** the sliding window is unlocked by sliding up the mechanism inside the handle. You will have a visual feedback of a green color when the door is unlocked. To lock the window, simply reverse the order and a red color will be visible.

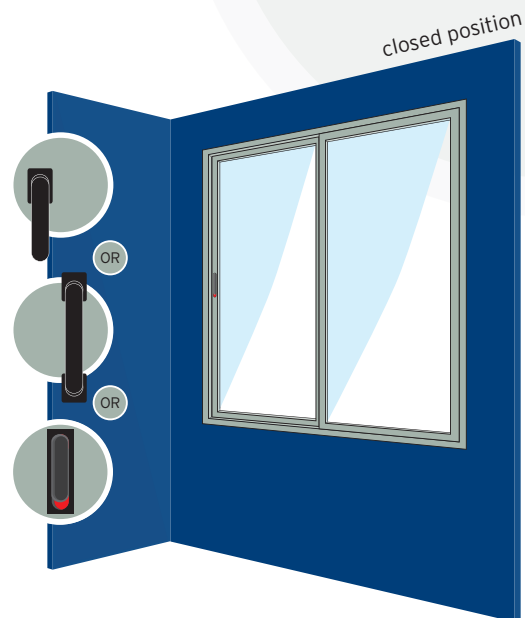

Please observe the safety remarks indicated on p. 5 - 8



## 2.1.12. FOLDING WINDOW

To open the element, every handle must be turned to a horizontal 'open' position first. The first sash must be positioned 90° to the rail and consequently, you can open the complete window by pulling (inward opening) or pushing (outward opening) the secondary handles.

To close, push the secondary handle (inward opening) or pull the secondary handle together with the auxiliary handle on the hinge (outward opening) until the sashes are positioned on top of the rail. Close the window by putting the handle in a downward position. The primary sash can be closed consequently.

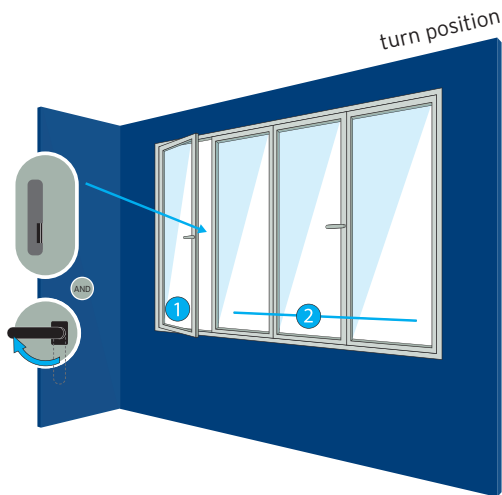
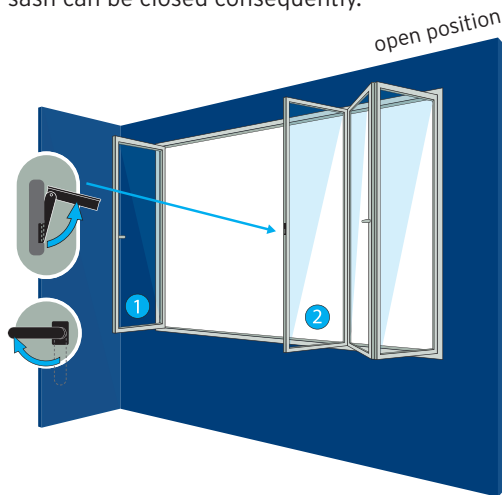
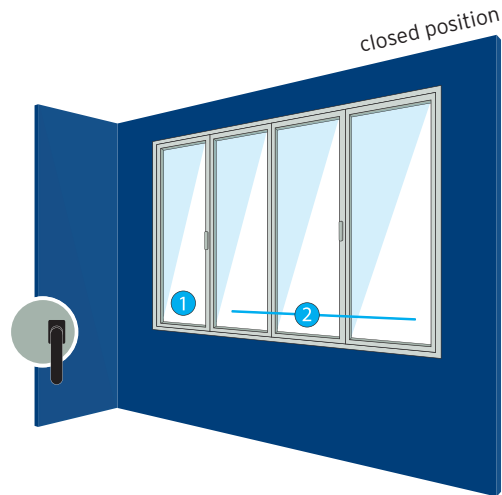

## 2.1.13. VENTALIS

The Ventalis system can regulate the ventilation of a room. Ventalis has 5 opening positions which determine the level of airflow. The flap can be opened manually or with an operation rod, for ventilation or maintenance purposes.

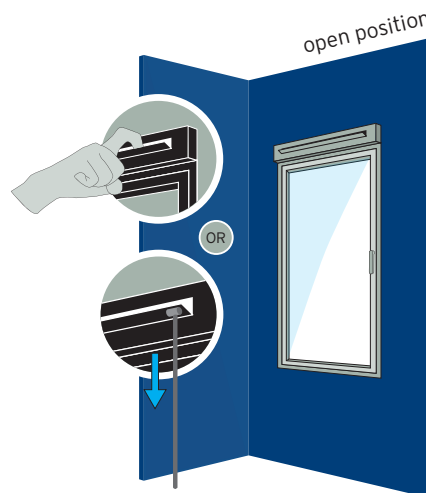

\* 1 active sash 2 inactive sash

Please observe the safety remarks indicated on p. 5 - 8



## 2.2. ACCESSORIES FOR WINDOWS

### 2.2.1. WINDOW HANDLES

#### TURN BEFORE TILT

Turn the window handle by 90° to achieve a turn position. By turning the handle 180°, a tilt position is obtained. If the handle is equipped with a cylinder lock, make sure this is unlocked as indicated on the drawing before operating the handle.

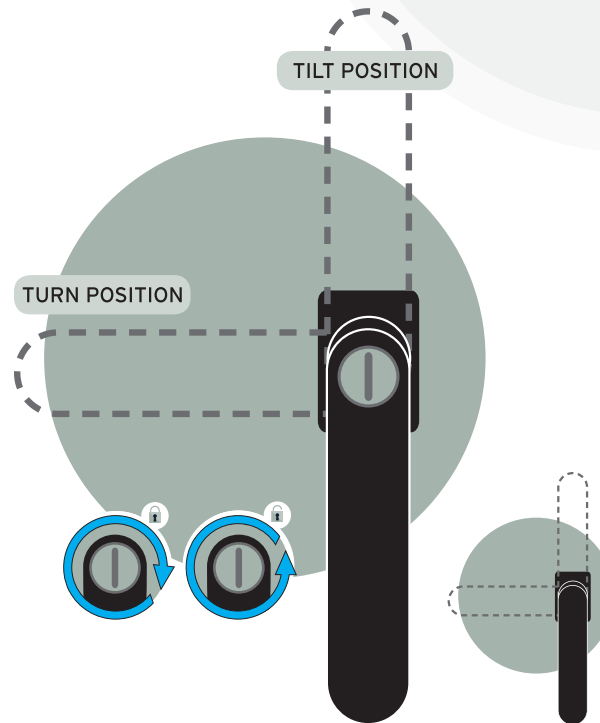

#### TILT BEFORE TURN

Turn the window handle by 90° to achieve a tilt position. By turning the handle 180°, a turn position is obtained. If the handle is equipped with a cylinder lock, make sure this is unlocked as indicated on the drawing before operating the handle.

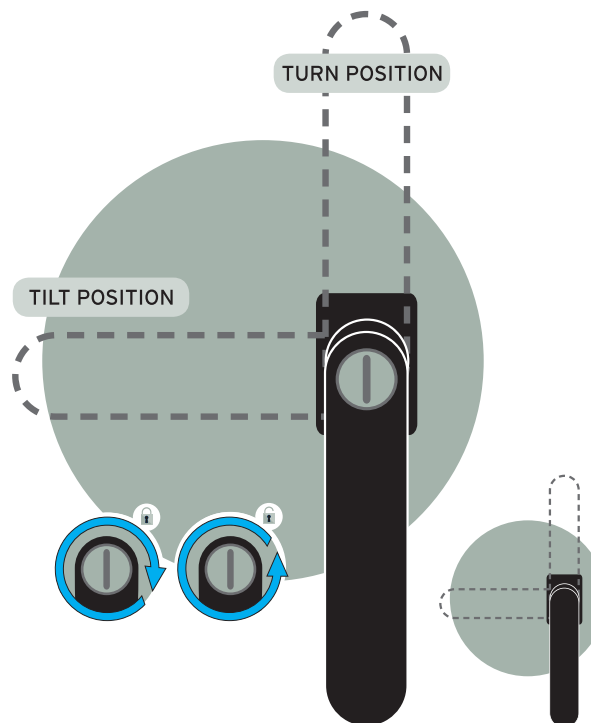

Please observe the safety remarks indicated on p. 5 - 8



### SPRING LATCH

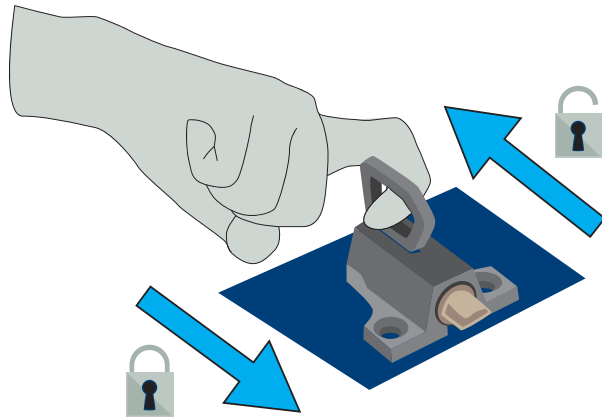

### INTEGRATED HANDLE

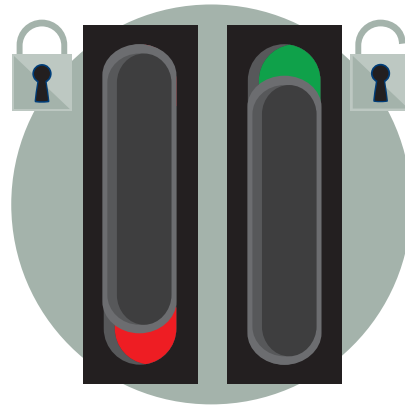

You will have a visual feedback of a green color when the door is unlocked. To lock the window, simply reverse the order and a red color will be visible.

---

## 2.2.2. RESTRICTOR

An opening restrictor can be used to determine the opening distance of an outward opening window up to 90°. It is possible to unlock the restrictor to open the window for cleaning or maintenance purposes.

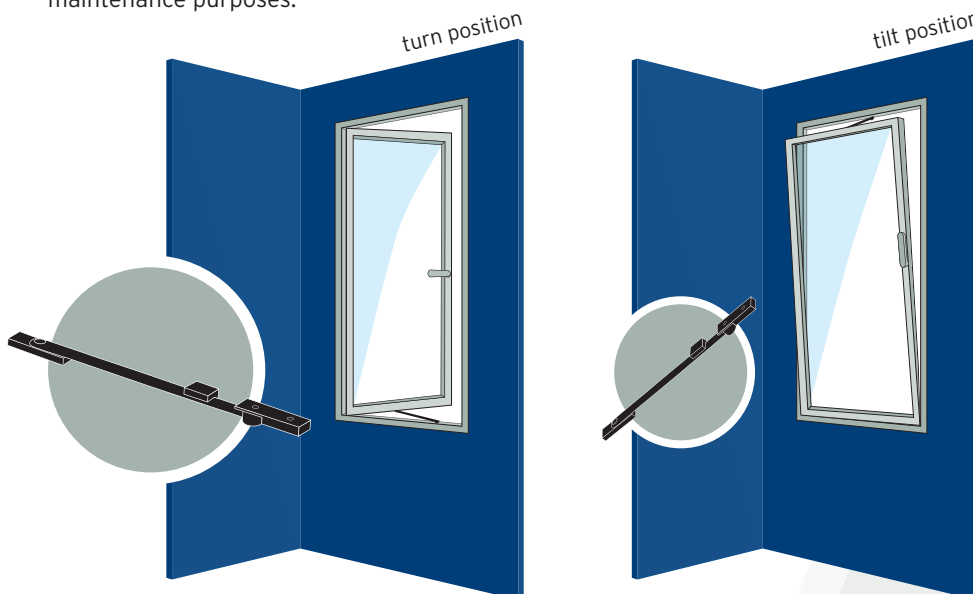

Please observe the safety remarks indicated on p. 5 - 8



### 2.2.3. VENTILATION SLID

The inward opening window can be equipped with a device to create a ventilation slid. This small space for ventilation can be obtained by first putting the window into a turn position and opening it slightly ( $\pm 1/4''$ ). Subsequently, the window handle should be pushed downwards by  $45^\circ$ . This places the window in a fixed ventilation position with a slight opening gap of  $\pm 1/4''$ .



### 2.2.4. BALCONY DOOR SNAPPER (ROLLER LOCK)

A balcony door snapper makes it possible to keep a balcony door closed without the need to operate any locking mechanism. It is activated by simply closing the door behind you when entering the balcony. To unlock it, simply push the fixed handle on the outside and the door is opened again. Operate the lock on the inside to activate the secure locking mechanism, keeping unwanted visitors from entering your home.

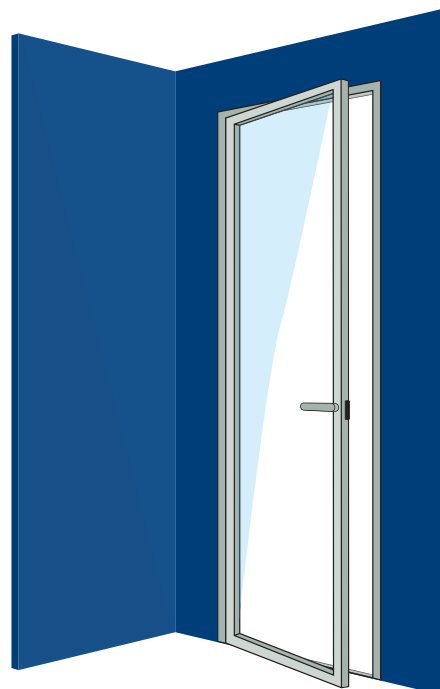



### 3. OPERATION OF DOORS



## 3.1. OPENING TYPES

### 3.1.1. SINGLE DOORS

To open a single door, push the handle downwards while pulling (inward opening) or pushing (outward opening) the door. To close the door, leave the handle in its original horizontal position and simply push or pull until the door is closed.



Please observe the safety remarks indicated on p. 5 - 8



### 3.1.2. DOUBLE DOORS

A double door consists out of two sections with a specific opening sequence. The door is equipped with a handle and the casement is equipped with locking bolts or central locking.

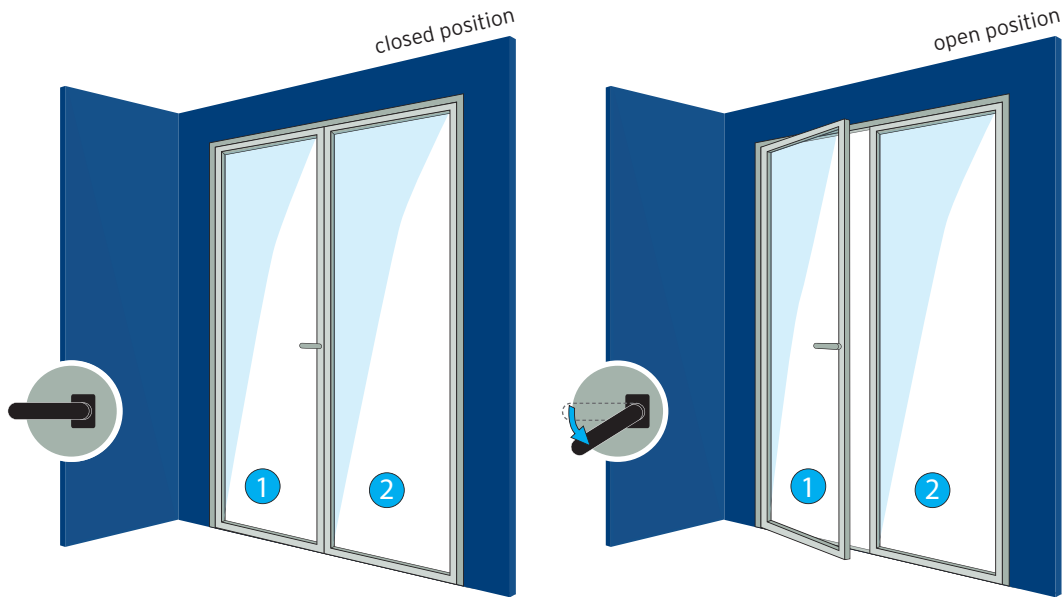

In order to open the second door, open the first door as indicated in the previous chapters. Subsequently, the locking bolts need to be unlocked before opening the second door. To close the doors, simply reverse the order.



Please observe the safety remarks indicated on p. 5 -8



### 3.1.3. PIVOTING DOORS

This element is equipped with either a normal or a fixed handle. By operating the handle, the door sash will pivot around the vertical central axis.

**Handle-operated:** to open the element, push the handle downwards while pulling or pushing the door.

**Fixed handle:** grab the handle and simply push or pull the door.



### 3.1.4. SLIDING DOORS

There are 3 types of opening mechanisms:

1. **Handle operated:** in order to open the sliding element, turn the handle to a horizontal position (quarter turn) and slide the window open. To close the element, simply reverse the order.



2. Sliding elements with a **fixed handle** are locked and unlocked by turning the cylinder.

3. **Integrated handle:** the sliding door is unlocked by sliding up the mechanism inside the handle. You will have a visual feedback of a green sticker when the door is unlocked. To lock the door, simply reverse the order and a red sticker will be visible.

Please observe  
the safety remarks  
indicated on p. 5 - 8



### 3.1.5. LIFT & SLIDE DOORS

By turning the door handle 180° into the sliding position, the sash is raised slightly. In order to close the sash, slide it into the closed position and lower it again by turning the handle 180° from the downward to the upward position. If the lift sliding door is equipped with a locking mechanism, unlock it before operating the handle.

It is possible to put the sliding system into a locked ventilation stand. Lower the sliding element +/- 1/2" before the closed position. This leaves a slight space for ventilation, while keeping unauthorized persons from entering.



Please observe the safety remarks indicated on p. 5 - 8



### 3.1.6. FOLDING DOORS

If the folding element is fitted with a walk-in door, this part of the element can be operated like a normal door.

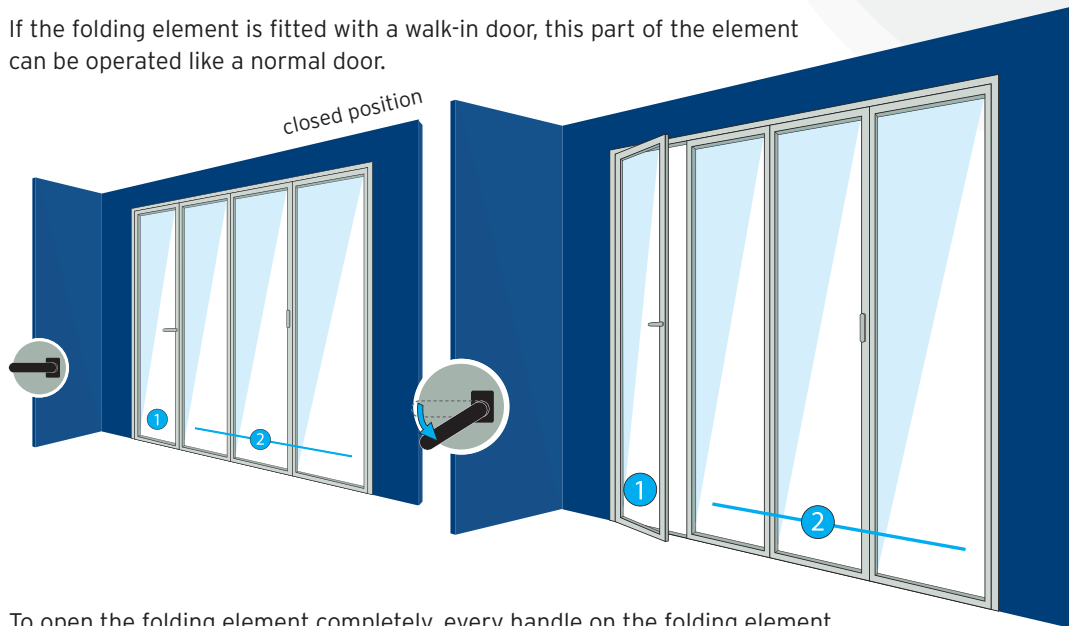

To open the folding element completely, every handle on the folding element must be turned to a horizontal 'open' position first.

The first sash must be positioned 90° to the rail and consequently, you can open the complete door by pulling (inward opening) or pushing (outward opening) the secondary handles. To close the folding door, push the secondary handle (inward opening) or pull the secondary handle together with the auxiliary handle on the hinge (outward opening) until the sashes are positioned on top of the rail. Close the door by putting the handle in downward position. The primary sash can be closed consequently.

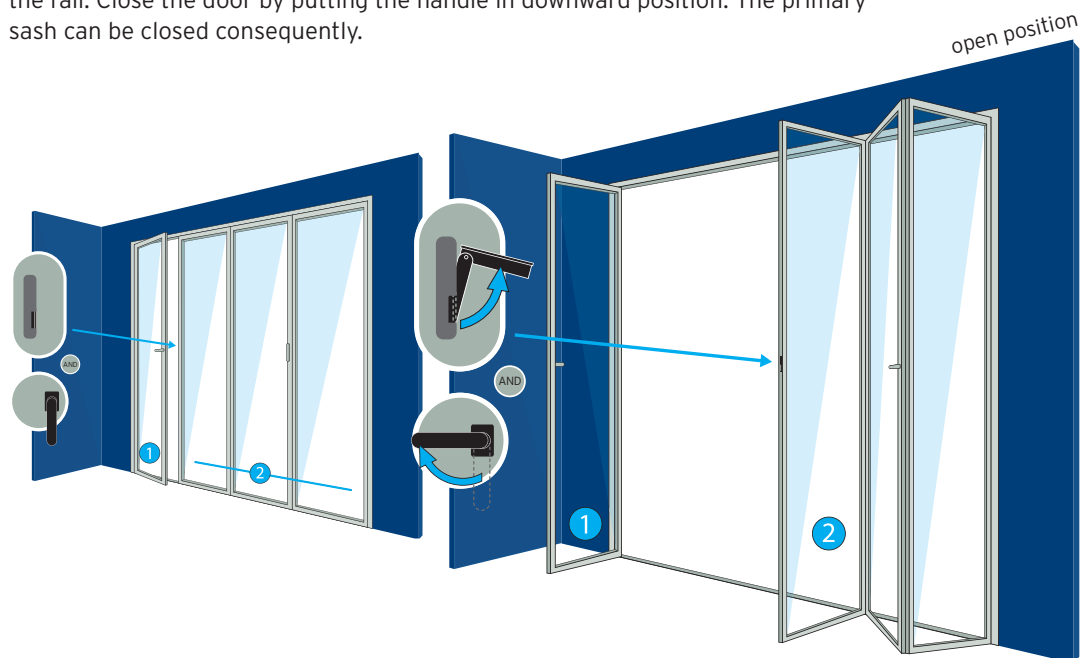

\* 1 active sash 2 inactive sash

Please observe the safety remarks indicated on p. 5 - 8



## 3.2. ACCESSORIES FOR DOORS

### 3.2.1. LOCKING AND UNLOCKING OF SINGLE DOORS

#### HANDLE OPERATED LOCK

When the door is in a closed position, move the handle upwards until you hear a click. This sound confirms that bolt and hook are in the locked position. To secure the lock, turn the key 1 turn clockwise.

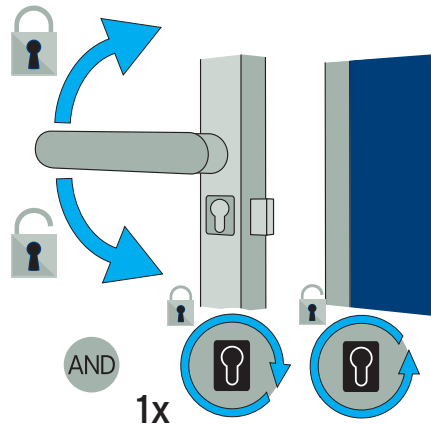

#### CYLINDER OPERATED LOCK

When the door is in a closed position, turn the key 2 complete turns to lock and secure the door. To open the door turn the key 2 complete turns counter clockwise and push the handle to open the door.

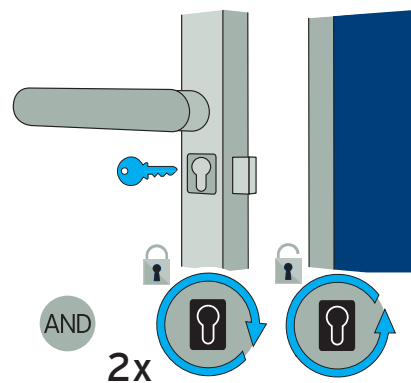

#### AUTOMATIC MULTI-POINT LOCK

An automatic locking system allows the door to be locked without any manipulation by the user. When the door is put into a closed position, the locking system is activated automatically. To secure the door, turn the key 1 turn clockwise. To unlock the door, turn the key 1 turn counter clockwise and push the handle down.

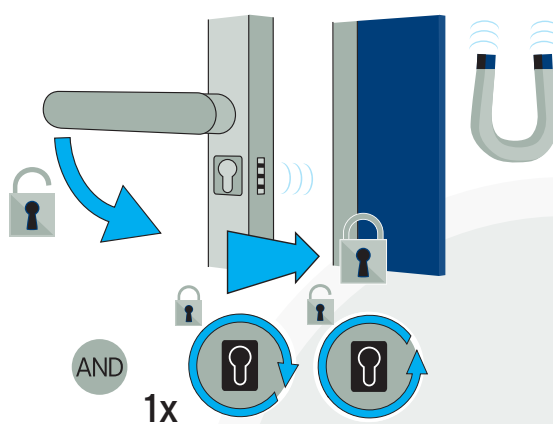

Please observe  
the safety remarks  
indicated on p. 5 - 8



### MOTOR OPERATED LOCK

The automatic locking mechanism is activated by pressing a button when the door is in a closed position. It can be unlocked in the same way.

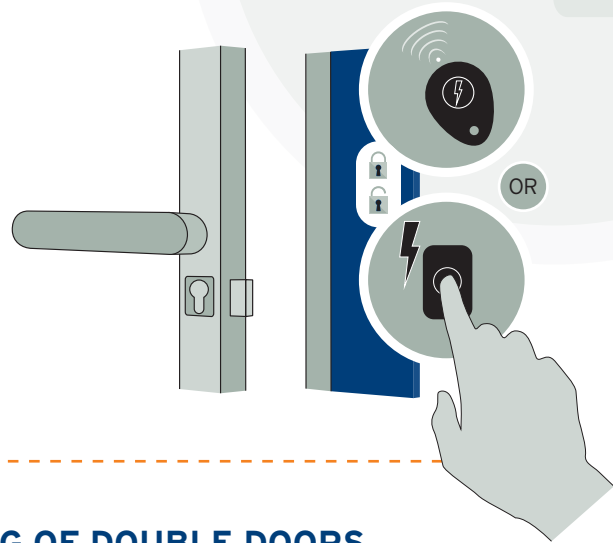

### 3.2.2. LOCKING AND UNLOCKING OF DOUBLE DOORS

First of all, the active door needs to be opened. Ways to open this first door are explained in previous chapters. In order to open the inactive door sash, the locking bolts on top and at the bottom of the door need to be manipulated as indicated on the drawing.

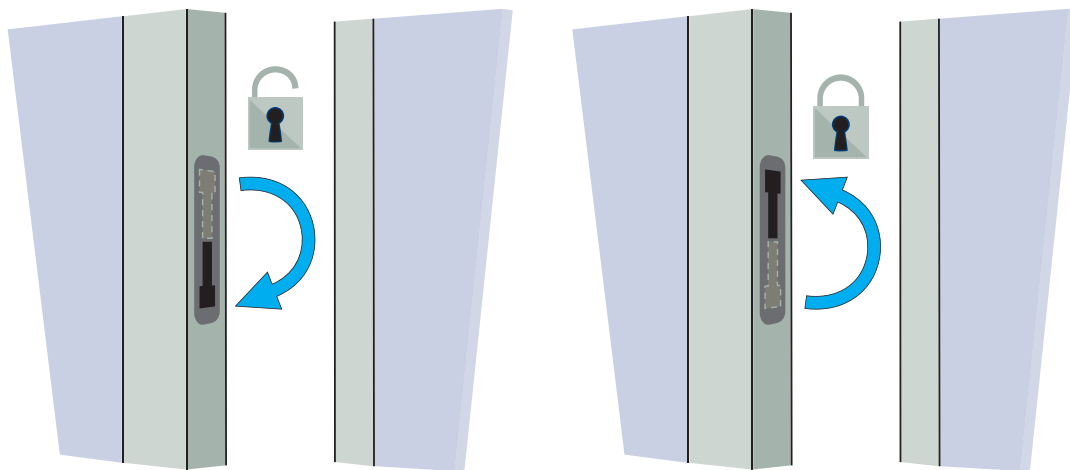



Please observe the safety remarks indicated on p. 5 - 8



### 3.2.3. LOCKING AND UNLOCKING ESCAPE DOORS / PANIC DOORS

#### PANIC DOOR

To open panic doors, operate the handles as indicated on the drawings.

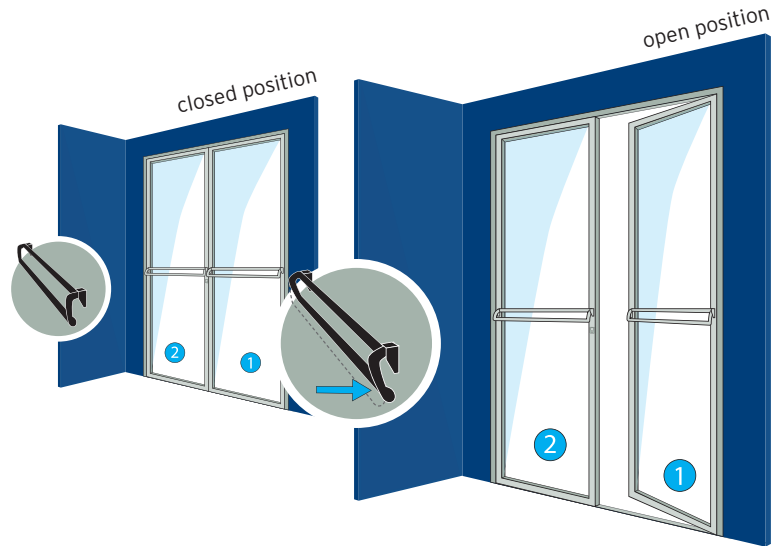

#### ESCAPE DOOR

The active sash is operated like a regular door. To open the inactive sash, the auxiliary handle should be turned by 180° from a downward to an upward pointing position.

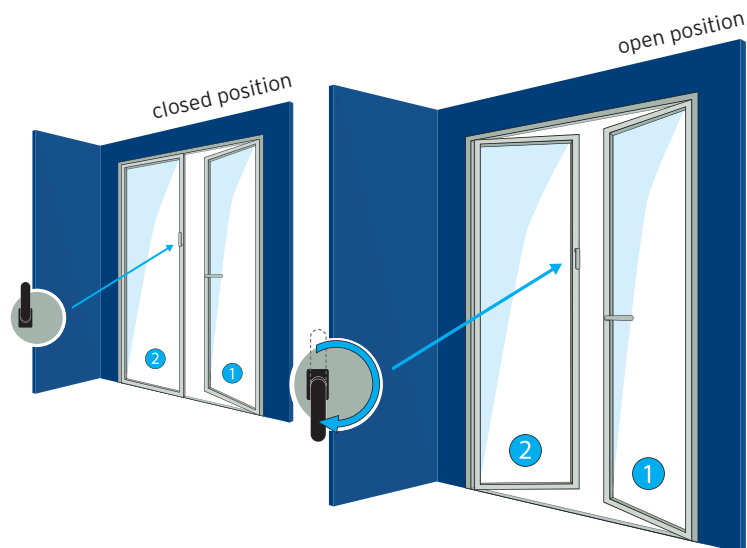

**NOTE:** For detailed guidelines on specific opening possibilities and operations, we refer to the specific system catalogs of Reynaers. If this is not available to you, a local Reynaers partner should be contacted.

Please observe  
the safety remarks  
indicated on p. 5 - 8



### 3.2.4. DOOR CLOSER

A door closer will automatically guide the door back to its closed position.



### 3.2.5. RESTRICTOR LOCK

The opening distance of a door can be limited for safety reasons by means of a restrictor lock. Operate the rotary knob to activate the locking mechanism and to allow for maximum 15cm of door opening. This safety measure will keep unauthorized persons from opening the door.

To open the door completely and to deactivate the restrictor lock, first close the door again. Subsequently, turn the rotary knob in the opposite 'open' direction. The door can now be opened normally.

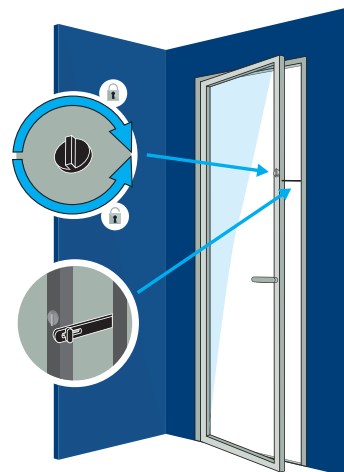

### 3.2.6. DOOR STOP

With a door stop, a door can be put in a fixed opened position.

1. Open the door up to the desired opening distance. Push your foot down on the lever to activate the stop-function.

2. Release by tapping your foot on the lever at the bottom of the door stop.



## 4. CARE AND MAINTENANCE



## 4.1. GENERAL INSTRUCTIONS FOR CLEANING AND MAINTENANCE

Regular cleaning and maintenance of your window and door elements is of great importance to assure their correct functioning and their lifetime. The aluminum construction needs regular maintenance, using non-aggressive cleansing agents, like tepid water with a non-aggressive, pH-neutral (6-8), non-acetone detergent, not containing ammonia.

Reynaers windows are equipped with high qualitative hardware. This results in smooth and long lifetime operation of the system. To ensure a flawless operation of the window, maximal weights and dimensions, as prescribed in our catalogs, have to be respected.

Function and status of the hardware can be controlled based on following criteria:

### OPERATION

The operation of the fittings can be checked on the handle. The force needed for locking and unlocking of the window is defined according to AAMA 513 cl 7.2.4. The operation ease can be increased by greasing or by adjusting the fittings.

### FASTENING OF THE HARDWARE

The operation of the system is depending on the correct fastening of the fittings to the window/door element. The strength and position of the screws in the aluminum profile should be checked. In case screws are loose or damaged, they should be fixed or replaced. Below are outlined methods, equipment and materials applicable for cleaning architecturally finished aluminum after construction and for subsequent periodic maintenance.

#### 4.1.1. PURPOSE

The methods outlined are intended for use on anodized or painted architectural products whether rolled or extruded shapes, including windows, doors, lift and sliding doors, bi-fold doors, curtain walls, sun screening and hardware.

Types of architectural finishes are: anodic coatings, thermoplastic and thermosetting organic coatings.

This information is intended as a guide for architects, owners, building managers, contractors and other in the building industry who are interested in the proper care and maintenance of finished architectural aluminum. Herein are described safe practical methods for cleaning, maintenance and protection of finished architectural aluminum.

#### 4.1.2. GENERAL

- **Anodized aluminum:** as with any finished building material, anodized aluminum requires reasonable care prior to and during installation and periodic cleaning and maintenance after installation. Although anodized aluminum possesses exceptional resistance to corrosion,

discoloration and wear, its natural beauty can be marred by harsh chemicals, rough conditions or neglect. Such conditions usually affect only the surface finish and do not reduce the service of the aluminum. However, the marks resulting from such mistreatment may be permanent. For example, mortar cement and other alkaline materials will quickly corrode anodic coatings if allowed to dry on the metal surface.

- **Painted aluminum:** organic coatings on aluminum do not normally show an appreciable amount of dirt collection. In many atmospheres dirt or soil would not indicate a detrimental risk to the coating but cleaning and surface care may be desirable for the sake of appearance. Cleaning may become desirable in areas where heavy industrial deposits have dulled the surface, where materials from construction processes have soiled the surface or where cleaner run-down from other surfaces should be removed.

Both painted and anodized surfaces, exposed to the atmosphere, collect soil and dirt, the amount of which may vary depending on geographic area, environmental conditions, finish and location on the building. Local atmospheric conditions as well as building location within a geographical area quite naturally have an effect on cleanliness.

More frequent cleaning will be required in heavy industrialized areas compared to rural areas. Seasonal rainfall can affect washing frequency by removing water soluble deposits and less adherent soil. In foggy coastal regions, frequent cycles of condensation and drying can create a heavy build-up of atmospheric salts and dirt which may adhere tenaciously. In climates where rainfall is low, the opportunity for atmospheric washing of the surface is minimal. Los Angeles, for example, has a unique combination of limited rainfall, temperature fluctuation, smog and condensation. This situation requires that cleaning be done more frequently than in other metropolitan areas where rainfall is more frequent.

In both wet and dry climates, recessed and sheltered areas usually become more heavily soiled because of the lack of rain washing. Frequent and longer periods of condensation also occur in protected areas increasing the adhesion of the soil. Periodic maintenance inhibits long-term accumulation of soil which, under certain conditions, can accelerate weathering of the finish. The more frequently the aluminum is cleaned, the easier and less costly succeeding maintenance is. It is recommended the finish supplier be consulted for proper cleaning schedule.

In any case, the aluminum cleaning schedule should be integrated with other cleaning schedules for efficiency and economy. For example, both the glass and the aluminum curtain wall on the same building can be cleaned at the same time.

### 4.1.3. CLEANING PROCEDURES AND CARE AFTER INSTALLATION

Construction soils, including concrete or mortar, etc., should be removed as soon as possible. The exact procedure for cleaning will vary depending on the nature and degree of soil. When selecting a method of cleaning and type of cleaner, consideration should be given to all other materials that may be adversely affected by the wash of the cleaning process. Try to restrict cleaning to mild weather. Cleaning should be done on the shaded side of the building or ideally on a mild, cloudy day.

## REMOVAL OF LIGHT SURFACE SOIL ON ORGANIC AND ANODIC COATINGS

Removal of light surface soil may be accomplished by alternative methods as described below. Only trial and error testing employing progressively stronger cleaning procedures can determine which will be most effective. Begin the cleaning process at the top of the building by rinsing an area the width of the stage or scaffolding to the ground level in continuous drop with forceful water spray. This should be done at the beginning and the end of each drop regardless of the final cleaning materials employed.

### 4.1.4. CLEANING PRECAUTIONS

Here's a common sense summary of cleaning recommendations for architectural aluminum finishes.

- Correctly identify the aluminum finish to be cleaned when selecting an appropriate cleaning method. Check specifications and/or "as-built" drawings if in doubt as to the finish.
- Never use aggressive alkaline or acid cleaners on aluminum finishes. Do not use cleaners containing trisodium phosphate, phosphoric acid, hydrochloric acid, hydrofluoric acid, fluorides, or similar compounds on anodized aluminum surfaces. Strong solvents or abrasive cleaners can cause damage to painted surfaces. Always follow the cleaner manufacturer's recommendations as to the proper cleaner and concentration. Test-clean a small area first. Different cleaners should not be mixed.
- It is preferable to clean the metal when shaded. Do not attempt to clean hot, sun-heated surfaces since possible chemical reactions on hot metal surfaces will be highly accelerated and non-uniform. Also, avoid cleaning in freezing temperatures or when metal temperatures are sufficiently cold to cause condensation. Surfaces cleaned under these adverse conditions can become so streaked or tainted that they cannot be restored to their original appearance.
- Apply the cleaning solution only to an area that can be conveniently cleaned without changing position. Thoroughly rinse the surface with clean water before applying cleaner. Minimize cleaner rundown over the lower portions of the building and rinse such areas as soon as practical.
- Strong cleaners should not be used on windows and other building accessories where it is possible for the cleaner to come in contact with the aluminum. Solutions of water and mild detergents should be tried first. If an aggressive cleaner is required for some other component of the building, care must be taken to prevent the cleaner from contacting the aluminum finish.

**NOTE:** Care should be taken to avoid over spray or run off of cleaner onto other buildings components such as glazing materials, weatherstripping sealants, etc.

- Do not use excessive abrasive rubbing to remove stubborn stains. Such procedures can produce an undesirable appearance or adversely affect the finish.
- The product must be cleaned at least twice annually, or at least 4 times annually in aggressive environments, or on rain-free parts or with the same frequency as glass, depending on local atmospheric requirements.

**CAUTION:**

- Hard materials such as knives, steel wool, metal scrapers, sandpaper, etc. can not be used to clean your windows and doors. These will damage the surface of your window and door elements.
- Aggressive or corrosive cleaning agents should be avoided as they can inflict irreversible damage to the surface treatment of your window -and door elements. Instead, use our dedicated range of Reynaers Care products. An overview of our care products can be found on page 51.

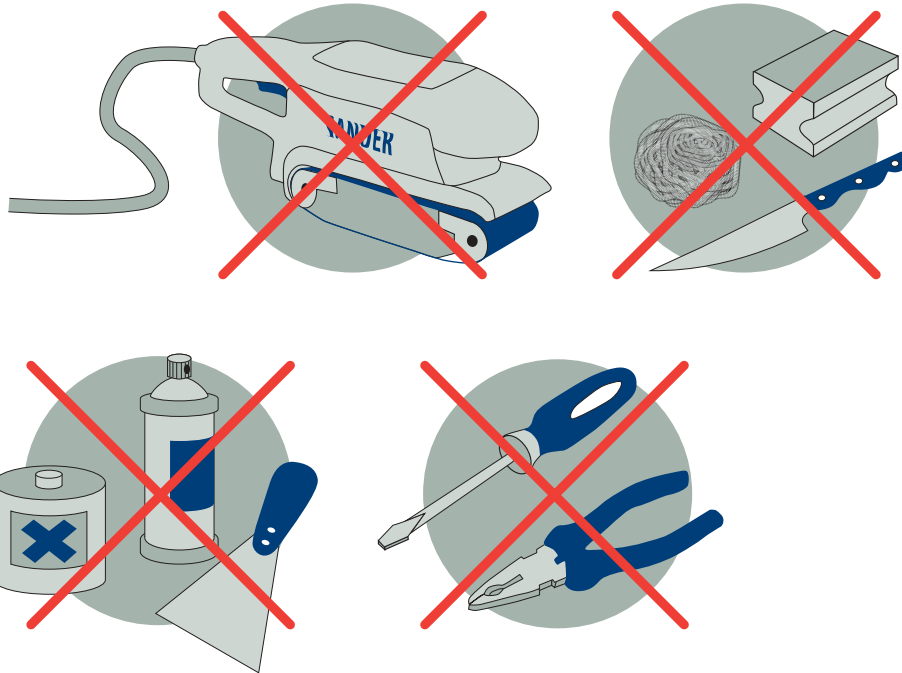

**NOTE:** Reynaers refers to **AAMA 609 & 610.02 Cleaning & Maintenance Guide for Architectural Finished Aluminum** for more detailed information on the care & maintenance of the finishes to your architectural products.

## 4.2. MAINTENANCE INTERVAL

Regular supervision of the elements is of major importance. The time frame interval between these check-ups depends on the installation situation and the amount of window or door movements. This is defined in the contract with your installer.

Any possible irregularities in the operation (slowness, unusual sounds, ...) which might occur during maintenance must be reported immediately to the concerned specialist. Windows and sliding doors should undergo regular maintenance to prolong their service life and to ensure their functionality and the conservation of value.

| OPENING TYPE             | USE  | FREQUENCY           | MAX. CYCLES   |
|--------------------------|--|---------------------|---------------|
| Door systems             | Limited use  | Once every 6 months | 50,000 cycles |
|                          | Normal use   |                     | 50,000 cycles |
|                          | Intensive use (Schools, Hospitals, public buildings,...) | Once every 3 months | 50,000 cycles |
|                          | Panic doors (EN 179 / EN 1125)                           | Once every month    | 50,000 cycles |
| Window / Sliding systems |  | Once every 6 months | 10,000 cycles |

Frequency of maintenance for profiles and hardware in **non-corrosive atmospheres** and provided that the aluminum constructions are exposed to rain: twice a year. In all other cases: minimum 4 times a year.

Some **corrosive atmospheres** or other risk factors (e.g. limited rain) may however require even more frequent cleaning to be observed by the end-user.

Non-exhaustive list of examples of such corrosive atmospheres/risk factors:

- near the coast (<6 miles) or close to estuary or large rivers (<3 miles);
- above water (condensation);
- within industrial areas, in particular areas with heavy emission of chemicals, fluorides, gasses, and ore materials;
- exposure to large traffic (motorways, railways, airports);
- very aggressive atmospheres (e.g. swimming pools, water treatment industry, laboratories, pollution by animals etc.)



## 4.3. PROPER PROCEDURES FOR CLEANING ARCHITECTURAL GLASS PRODUCTS

Architectural glass products play a major role in the comfort of living and working environment of today's homes and commercial office spaces. By providing natural daylight, views of the surroundings, thermal comfort and design aesthetics, glass usage and condition often affect our selection of where we live, work, shop, play and seek education.

Architectural glass products must be properly cleaned during construction activities and as a part of routine maintenance in order to maintain visual and aesthetic clarity. Since glass products can be permanently damaged if improperly cleaned, it is imperative that proper procedures for cleaning are adhered to.

As dirt and residue appear, interior and exterior glass surfaces should be thoroughly cleaned. Concrete or mortar slurry which runs down (or is splashed on) glass can be especially damaging and should be washed off as soon as possible. Before proceeding with cleaning, determine whether the glass is clear, tinted or reflective. Surface damage is more noticeable on reflective glass as compared with the other glass products. If the reflective surface is exposed, either on the exterior or interior, special care must be taken when cleaning, as scratches to the reflective glass surface can result in coating removal and a visible change in light transmittance. Cleaning tinted and reflective glass surfaces in direct sunlight should be avoided, as the surface temperature may be excessively hot for optimum cleaning. Cleaning should begin at the top of the building and continue to the lower levels to reduce the risk of leaving residue and cleaning solutions on glass at the lower levels. Cleaning procedures should also ensure that the wind is not blowing the cleaning solution and residue onto already cleaned glass.

Cleaning during construction activities should begin with soaking the glass surfaces with clean water and soap solution to loosen dirt or debris. Using a mild, non-abrasive commercial window washing solution, uniformly apply the solution to the glass surfaces with a brush, strip washer or other non-abrasive applicator. Immediately following the application of the cleaning solution, a squeegee should be used to remove all of the cleaning solution from the glass surface. Care should be taken to ensure that no metal parts of the cleaning equipment touch the glass surface and that no abrasive particles are trapped between the glass and the cleaning materials. All water and cleaning solution residue should be dried from window gaskets, sealants and frames to avoid the potential for deterioration of these materials as the result of the cleaning process.

It is strongly recommended that window washers clean a small area or one window, then stop and examine the surface for any damage to the glass and/or reflective coating. The ability to detect certain surface damage, i.e. light scratches, may vary greatly with the lighting conditions. Direct sunlight is needed to properly evaluate a glass surface for damage. Scratches that are not easily seen with a dark or gray sky may be very noticeable when the sun is at a certain angle in the sky or when the sun is low in the sky.

The glass industry takes extreme care to avoid glass scratches by protecting all glass surfaces during glass manufacturing and fabrication, as well as during all shipping and handling required to deliver the glass to the end user. A large percentage of damaged glass results from non-glass trades working near glass. This will include painters, spacklers, ironworkers, landscapers, carpenters and others who are part of the construction process. They may inadvertently lean tools against the glass, splash materials onto the glass and/or clean the glass incorrectly, any of which can

permanently damage glass.

One of the common mistakes made by non-glass trades people, including glass cleaning contractors, is their use of razor blades or other scrapers on a large portion of the glass surface. Using 2, 3, 4, 5 inch and larger blades to scrape a window clean carries a large probability for causing irreparable damage to glass.

The entire industry of glass manufacturers, fabricators, distributors, and installers neither condones nor recommends widespread scraping of glass surfaces with metal blades or knives. Such scraping will often permanently damage or scratch the glass surfaces. When paint or other construction materials cannot be removed with normal cleaning procedures, a new 1" razor blade may need to be used only on non-coated glass surfaces. The razor blade should be used on small spots only. Scraping should be done in one direction only. Never scrape in a back and forth motion as this could trap particles under the blade that could scratch the glass. This practice may cause hairline concentrated scratches, which are not normally visible when looking through the glass, but may be visible under certain lighting conditions.

Job site storage and construction conditions can lead to stains on the glass surface. Cleaning and removal of such stains may require the use of a more aggressive cleaning solution and procedure. If conditions are found that cannot be cleaned using the above procedures, contact the glass supplier for guidelines on stain removal.

Members of the Glass Association of North America (GANA) publish information relating to job site protection and cleaning of architectural glass products. In order to ensure long-term performance of the glass in a building, GANA encourages glazing contractors, general contractors, building management and owners to be aware of conditions that can damage glass and to follow the handling and cleaning guidelines provided by their glass producer and fabricator.

Consult the GANA website ([www.glasswebsite.com](http://www.glasswebsite.com)) for additional information on glass and glazing applications and links to members providing additional technical resources.

- **DO** clean glass when dirt and residue appear
- **DO** determine if coated glass surfaces are exposed
- **DO** exercise special care when cleaning coated glass surfaces
- **DO** avoid cleaning tinted and coated glass surfaces in direct sunlight
- **DO** start cleaning at the top of the building and continue to lower levels
- **DO** soak the glass surface with a clean water and soap solution to loosen dirt and debris
- **DO** use a mild, non-abrasive commercial window cleaning solution
- **DO** use a squeegee to remove all of the cleaning solution
- **DO** dry all cleaning solution from window gaskets, sealants and frames
- **DO** clean one small window and check to see if procedures have caused any damage
- **DO** be aware of and follow the glass supplier's specific cleaning recommendations
- **DO** caution other trades against allowing other materials to contact the glass
- **DO** watch for and prevent conditions that can damage the glass
- **DO** read the entire GANA bulletin on glass cleaning before starting to clean glass
  
- **DO NOT** start cleaning without reading the entire GANA bulletin on glass cleaning
- **DO NOT** use scrapers of any size or type for cleaning glass
- **DO NOT** allow dirt and residue to remain on glass for an extended period of time
- **DO NOT** begin cleaning glass without knowing if a coated surface is exposed
- **DO NOT** clean tinted or coated glass in direct sunlight

- **DO NOT** allow water or cleaning residue to remain on the glass or adjacent materials
- **DO NOT** begin cleaning without rinsing excessive dirt and debris
- **DO NOT** use abrasive cleaning solutions or materials
- **DO NOT** allow metal parts of cleaning equipment to contact the glass
- **DO NOT** trap abrasive particles between the cleaning materials and the glass surface
- **DO NOT** allow other trades to lean tools or materials against the glass surface
- **DO NOT** allow splashed materials to dry on the glass surface

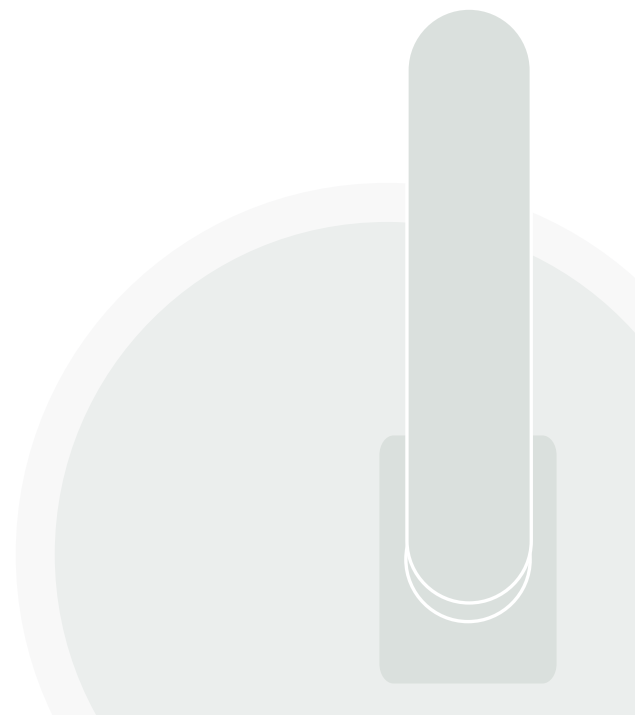

## 4.4. OVERALL MAINTENANCE

### 4.4.1. MAINTENANCE OF DRAINAGE SLOTS

Clean the chamber between the moving and the fixed part every 6 months. If necessary, clear the drainage slots of any blockage.

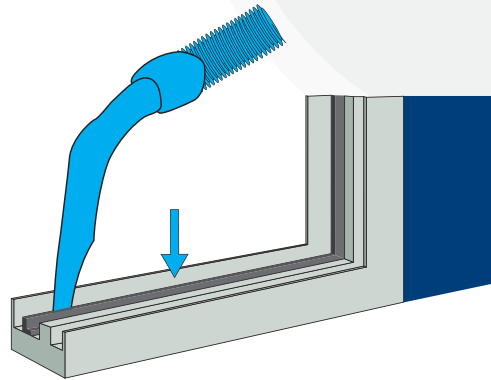

### 4.4.2. MAINTENANCE OF RAILS IN SLIDING AND LIFT- AND SLIDE ELEMENTS

Dirt and sand might collect in the bottom profile of your sliding/folding door. Clean the gutter(s) every month. If necessary, clear the drainage holes of any blockage. Remove the dirt, dust, grease and graphite annually from the rail with a cloth.

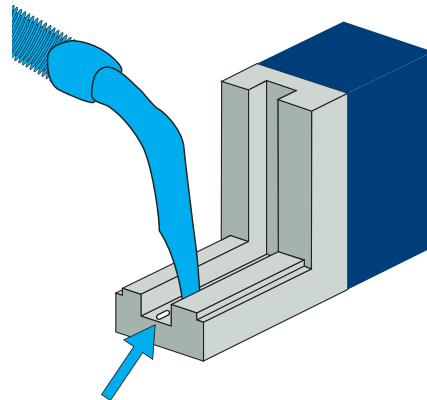

### 4.4.3. MAINTENANCE OF GASKETS

Once a year, apply normal domestic talc to the gaskets (in EPDM) between the moving and the fixed part of the element, or apply liquid silicone (by means of a cloth), to avoid cracks and deposits.

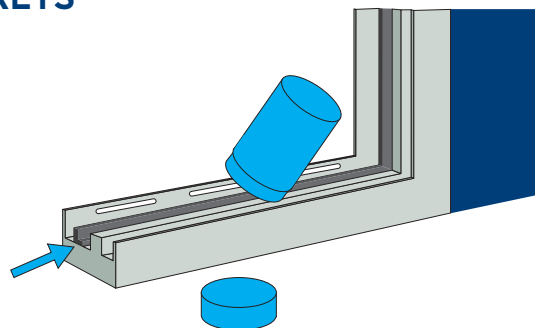

#### 4.4.4. MAINTENANCE OF HARDWARE AND ACCESSORIES

Remove the dust, grease and graphite annually\* from the following areas. Clean hardware exclusively with a soft cloth and mild, pH-neutral cleaning materials in diluted form.

- Window gearing
- Friction hinges
- Moving parts of the handles
- Locks and cylinders, using a graphite pipette and graphite powder
- The opening restrictor of the sliding element

\* The frequency depends on opening type and environment, please check specifications in chapter 4.2.

#### CAUTION:

- **Avoid silicon lubricants**, rather use a dry cloth and fitting oil in the REYNACLEAN box (086.9220) to protect the surface and prevent dust collection on the hardware parts.
- **Do not lubricate** the composite rods or door hinges.

Never use aggressive acidiferous cleaning materials or scouring agents. These can cause damage to the hardware.

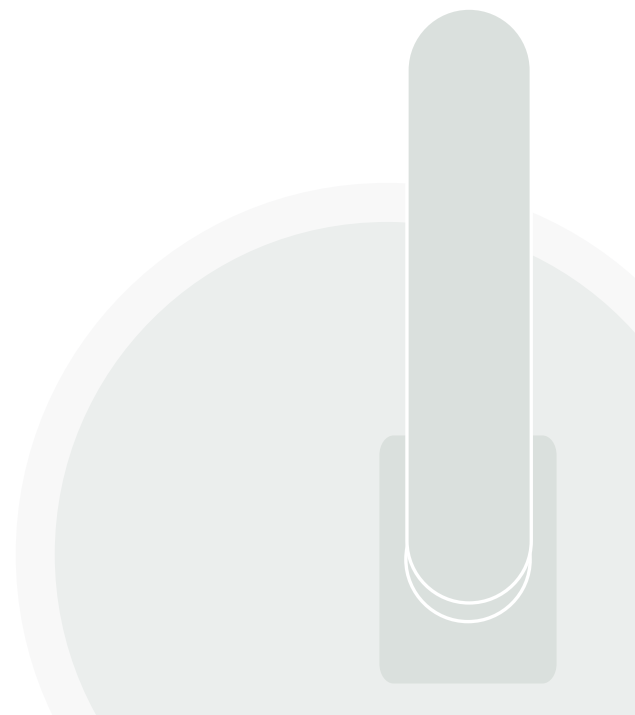



## 4.5.2. WINDOWS WITH FRICTION STAY

**Step 1:** clean all dirt, dust and debris from all parts of the product and keep any obstructions away from the pivoting and sliding parts.

- Use a vacuum cleaner or a small soft brush to remove dry materials.
- Use a dry cloth to remove any remains of dirt.

**Step 2:** check that all fixing screws are present and are securely and fully tightened.

**Step 3:** verify that other hardware fitted to the window assembly, e.g. hinges, locking mechanism(s), handles, motors, etc. are operating correctly.

**Step 4:** lubricate all pivoting and sliding parts of the products using high quality light, machine oil, such as provided in the ReynaCare box.

- One drop per pivot or sliding part is sufficient.
- Do not use a WD40-type or silicone-based maintenance spray for lubrication purposes.

**Step 5:** wipe any excess lubricating oil over the surfaces of the hinge mechanism links using a soft, lint free cloth.

**Step 6:** check the correct and smooth operation of the sash.

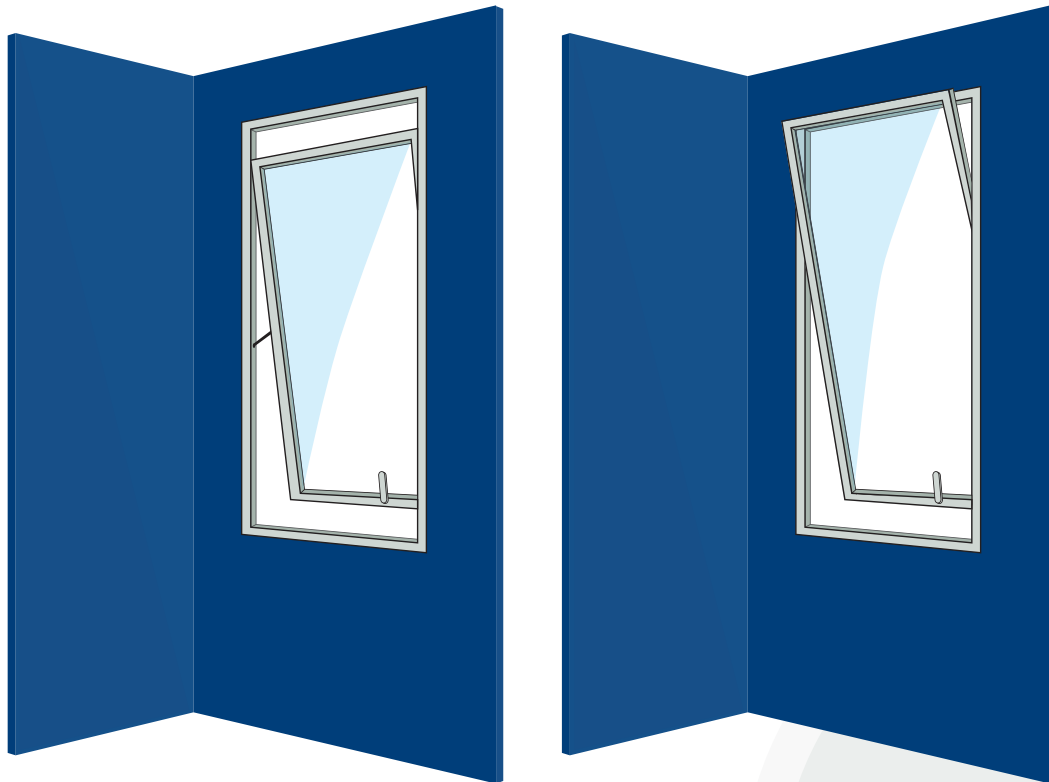

## 4.6. CLEANING AND MAINTENANCE OF DOORS

### 4.6.1. SINGLE & DOUBLE DOORS

#### DOOR LOCKS

Safety-relevant hardware should be checked at least annually\* for wear and tear and a continuous firm fit. Depending on the requirements, fixing screws have to be tightened. The damaged or worn parts should be exchanged by original parts by an authorized specialist.

All movable parts and locking parts have to be oiled and their working order should be checked. The cylinder can be maintained by using graphite powder.

\* The frequency depends on the opening type and environment, please check specifications in chapter 4.2.

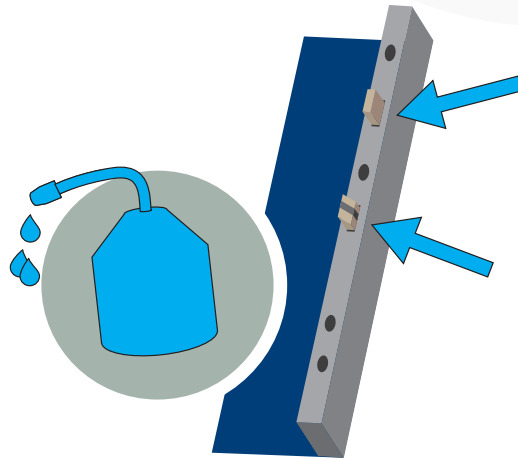

#### DOOR HINGES

In general, hinges are maintenance free and don't need to be greased.

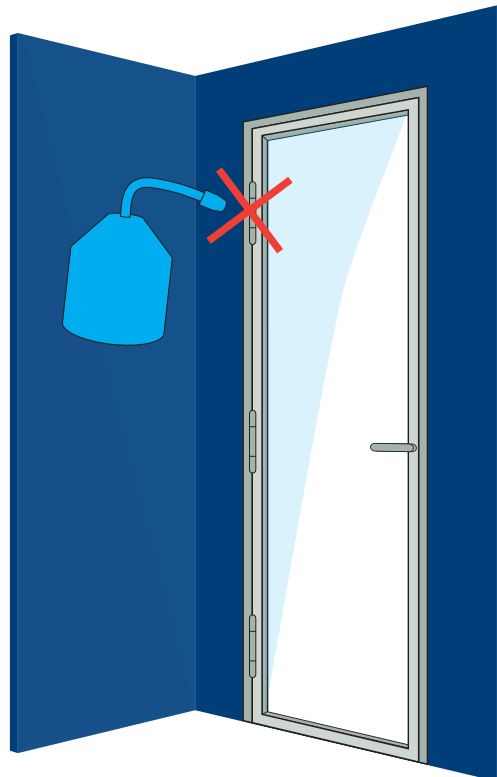



## DOOR CLOSERS

Safety elements of door closers must be checked for wear regularly to ensure that they are fitted correctly and securely. Fixing screws must be tightened and any damaged components must be changed.

The frequency depends on the opening type and environment, please check specifications in chapter 4.2. Furthermore, the following maintenance work must be performed at least once a year (depending on the type of hinged leaf doors and their applications):

- All moving parts on the link arm must be greased
- The closer settings (e.g. closing speed) must be checked
- Smooth operation of the door must be checked
- In the case of door closers with special functions (hold-open devices / hold-open systems), the legal check, monitoring, and maintenance must be observed
- Door closers and / or defective parts must be replaced immediately if their proper function is no longer guaranteed.

Only cleaning agents without corrosive and damaging components should be used.

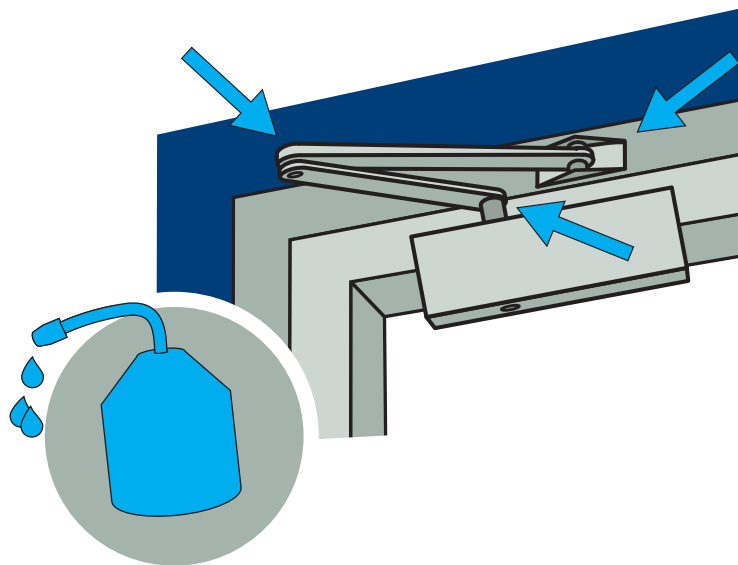

## 4.6.2. SLIDING DOOR

### SLIDING ELEMENT

All safety aspects of the gear, more specifically the fixings of the lock, lock keeps, hook keeps and door handles, should be checked regularly. All gear adjustments, especially of the keeps and roller assemblies, the replacement of parts and installation and removing of the sashes should be executed by a window expert. Maintenance should be carried out at suitable intervals (see specifications in chapter 4.2) relative to the amount of use and environmental conditions.

Follow these instructions:

- Check the operation of the components.
- Any dust and dirt must be removed from the components as this could affect the smooth operation of the system.
- Clean the mechanism and remove any traces of dirt. Use a soft cloth and mild, pH-neutral cleaning materials in diluted form.
- After cleaning the hardware surface, treat it with silicone and corrosion free (i.e. non-acidic) oil, e.g. ReynaCare box.

### LIFT & SLIDE ELEMENT

To ensure the smooth and trouble free operation, you must carry out the following maintenance instructions at least once a year:

- Lubricate or oil all locking parts.
- Use only clean and non-resinous grease or oil.
- After cleaning the hardware surface, treat it with silicone and corrosion free (i.e. non-acidic) oil, as provided in the ReynaCare box.

### CAUTION:

The following work should only be performed by an authorized specialist:

- The replacement of fittings
- The assembly/dismantling of sashes



## 4.7. CLEANING AND MAINTENANCE OF OTHER SYSTEMS

### VENTALIS

1. Open the flap of the ventilation grid completely
2. Clean the inside using a vacuum cleaner and/or damp cloth.



## 4.8. CARE PRODUCTS

To ensure a lifelong and optimal functioning of your window -and door elements, Reynaers provides a complete range of care products for aluminum profiles. Here is an overview of our care product range with a brief product description. Remember to carefully read the instructions on the product labels.



### REYNOVATOR 718 *(Art. No: 086 9211 / 500 ml / Sold per one)*

- All-in-one total renovation oil used for restoration, conservation and maintenance of already installed aluminum surfaces (powder-coated and anodized)
- Protection against corrosion
- Adds shine
- Originates treating protective film



### REYNAWASH COLOR *(Art. No: 086 9212 / 500 ml / Sold per one)*

- Color cleaner for periodical application and maintenance.
- For all surfaces, including texture coating, powder-coated and film-laminated frames, as well as the glass surfaces
- Accurate and easy dosage
- Solvent-free
- Ph-neutral



### REYNAWASH ANO *(Art. No: 086 9213 / 500 ml / Sold per one)*

- Adds new shine to older profiles
- Cream cleaner for periodical application
- For all anodized aluminum surfaces
- Solvent-free

### REYNACARE BOX *(Art. No: 086 9220 / Sold per one)*

- Combination of all necessary maintenance products
- This box includes:
- ReynaWash color: 200 ml
- Fitting oil: guarantees the smooth-running of the mobile parts & protects against corrosion
- Maintenance stick: prevents gaskets from clinging
- Cleaning cloth
- Small, handy units



## 5. IMPORTANCE OF CLIMATE CONTROL AND VENTILATION



## 5.1. AIR TIGHTNESS COMBINED WITH GOOD VENTILATION

The Reynaers windows, doors and sliding systems are designed to be airtight. This means that, in closed position, almost no air circulation is caused by natural draft through the windows. However, water vapor is generated by daily activities in the house like cooking, showering and the inhabitants themselves. This vapor can cause condensation on walls and windows and, in a further evolved stage, cause stains, fungus and decaying of the plaster wall. To avoid the negative effects of the moisture/vapor, rooms should be well ventilated.

This can be achieved as follows:

1. Opening the window completely for a few minutes every day
2. Put it in a tilt position for a longer time
3. Install a **Ventalis** (intelligent ventilation grid) on top of the window/sliding system for continuous controlled ventilation.

## 5.2. VENTILATION AND CLIMATE CONTROL

1. To avoid loss of heating energy long-term uncontrolled draft should be avoided. Putting the window on a tilt position during winter time is therefore not recommended.
2. Short term maximal ventilation of the room, by opening the window completely, has less effect on the heat loss and is preferred above long term, uncontrolled ventilation.
3. Controlled ventilation with Ventalis defines a maximal airflow through the grid and closes off automatically with high wind pressures to avoid drought. Positioned in the dry areas of the home (bedroom, living room), fresh air flows in. Typically the bathroom and kitchen have extractors that pull the fresh air through the house and push the moist air outside. This Ventalis solution provides fresh air all day/night long, limits the heat loss while offering a secure solution (anti burglary).

## 6. RECOMMENDATIONS



## REYNAERS RECOMMENDATIONS

1. It is extremely important that repair works are performed by the supplier of your systems. In this way the system guarantee remains preserved. Your Reynaers professional disposes of qualified personnel and specialized tooling for the required maintenance or reparation works.
2. Hardware parts of the Reynaers system should only be replaced by the original parts provided by your Reynaers Installer.
3. In case this manual does not provide an answer to all your questions, please contact your local Reynaers professional. They can give you detailed advice on the operation, care and maintenance of your Reynaers window and door systems.
4. During maintenance activities, the physical properties should be considered. Especially the direct contact between glass, sealing components, silicone and facade elements.



## ABOUT REYNAERS

Reynaers Aluminium is a leading European specialist in the development and marketing of innovative and sustainable aluminum solutions for windows, doors, curtain walling, sliding systems and sun screening. Besides offering an extensive range of standard solutions, the company also develops solutions that are tailored to the individual customer or project. In addition, the company also provides extensive technical support and advice to dealers, architects and installers. Research, product development and testing are conducted at the Reynaers Institute, the sector's largest private innovation and testing center, located in Duffel (Belgium). All testing for the North American market is carried out to AAMA/WDMA/CSA 101/I.S. 2/A440 standards by an AAMA certified laboratory.



**REYNAERS**  
aluminium

**TOGETHER FOR BETTER**

**REYNAERS INC.**

21430 N 15th Ln, Ste 100 · Phoenix, AZ 85027  
t (480) 272-9688 · f (623) 455-9146  
www.reynaers.us · info@reynaers.us